

Mirage Liberty™

FULL FACE MASK





Components Guide

English

Complete system

S **61300** L **61301**

Frame system* (no headgear)

	 (S)	 (M)	 (L)
 (S)	61318	61319	61320
 (L)	61321	61322	61323

Frame assembly* (no headgear, cushion or pillows)

S **61325** L **61326**

Elbow assembly (elbow, valve and clip)

61340

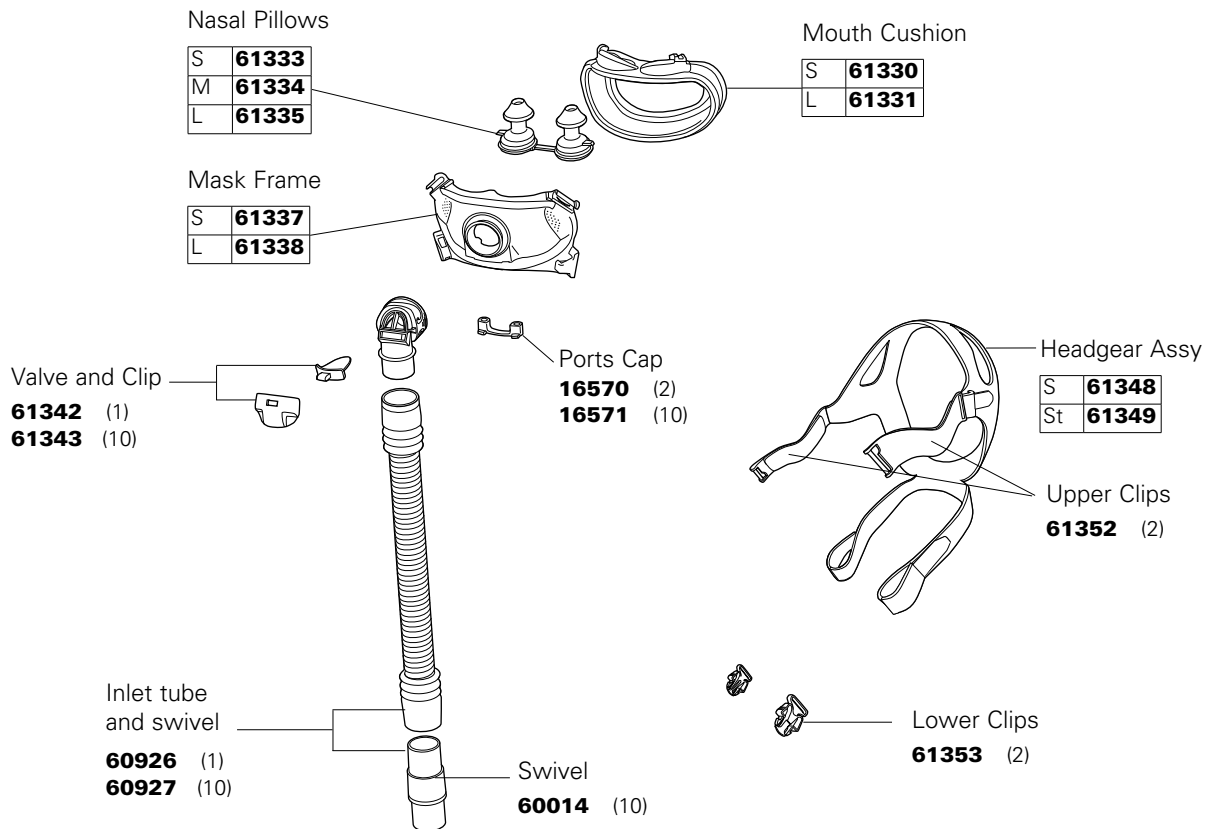

S Small M Medium L Large St Standard * contains lower headgear clips

 For details, refer to the *Mirage Liberty User Guide*.

Manufacturer: ResMed Ltd 1 Elizabeth Macarthur Drive Bella Vista NSW 2153 Australia. **Distributed by:** ResMed Corp 14040 Danielson Street Poway CA 92064-6857 USA, ResMed (UK) Ltd 96 Milton Park Abingdon Oxfordshire OX14 4RY UK. See www.resmed.com for other ResMed locations worldwide. Mirage and Mirage Liberty are trademarks of ResMed Ltd and Mirage is registered in U.S. Patent and Trademark Office. Specifications may change without notice. © 2009 ResMed Ltd. 1011556/4 09 03